

ITEM

7810PA40K2

WALLBOX CM 42

Product Type



Logistic Info

Pcs per Carton: 20
Qty per Pallet: 20
Unit weight: 0,71900
Flow rate Lt/m.:

ORIGINE: MADE IN CINA

Cod.EAN13: 8030575030234

Tarif Code :39229000

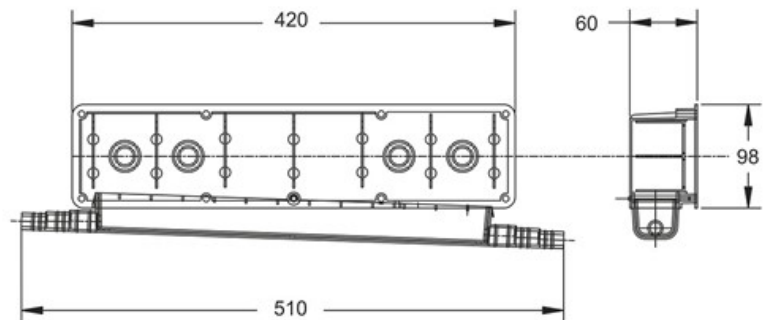

Tecnichal Details

Model: WALLBOX
Product: Air-conditioning device condensating water catcher
Spec 1: Double connecting nozzle
Spec 2: 42 cm long box
Material 1: PS
Material 2: PE
Color 1: WHITE
Color 2: GREEN

Approvals