

ITEM

**6895AC50S**

**CANALISSIMA AC CENTRALE L.50CM**

Product Type

Channel drains

Channel drains with stainless steel grid



Logistic Info

**Pcs per Carton:**

**Qty per Pallet:**

**Unit weight: 1,02500**

**Flow rate Lt/m.:**

ORIGINE: MADE IN ITALY

Cod.EAN13: 8030575041827

Tarif Code :73249000

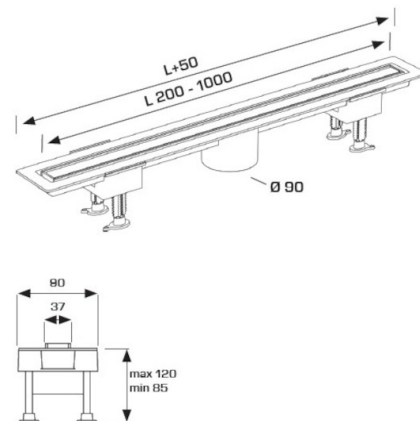

Tecnichal Details

**Model:** CANALISSIMA - ACCIAIO - CENTRALE

**Product:** Channel drains with central outlet

**Spec 1:** "DOUBLE FACE" adjustable full stainless steel AISI316 tileable grid

**Spec 2:** L 50 cm

**Material 1:** INOX

**Material 2:** ABS

**Color 1:** BRUSHED

**Color 2:** BLACK

Approvals