

ITEM

6835MX110S

CANALISSIMA MX APERTA L.110 CM

Product Type

Channel drains

Channel drains - Custom

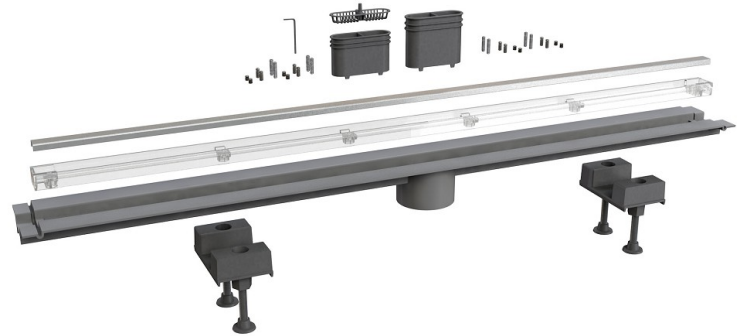

Logistic Info

Pcs per Carton:

Qty per Pallet:

Unit weight: 1,98400

Flow rate Lt/m.:

ORIGINE: MADE IN ITALY

Cod.EAN13: 8030575042619

Tarif Code :73249000

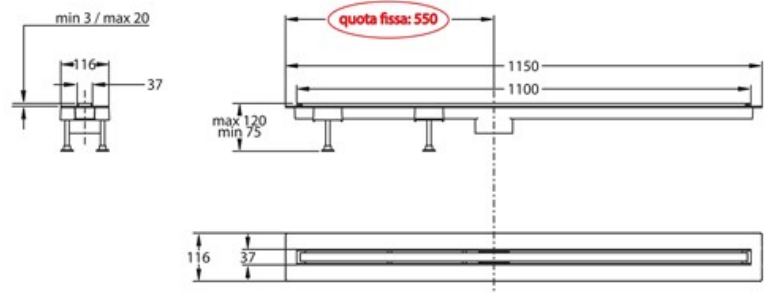

Tecnichal Details

Model: CANALISSIMA - MIXAGE - COMPONENTE

Product: Custom-made channel drains

Spec 1: "MIXAGE" adjustable tileable grid with PMMA frame and stainless steel AISI316 insert

Spec 2: L 110 cm

Material 1: INOX

Material 2: ABS

Color 1: BRUSHED

Color 2: TRANSPARENT

Approvals