

ITEM

6825HX40S

CANALISSIMA MX KIT ORIZ L40CM

Product Type

Channel drains

Channel drains - kit

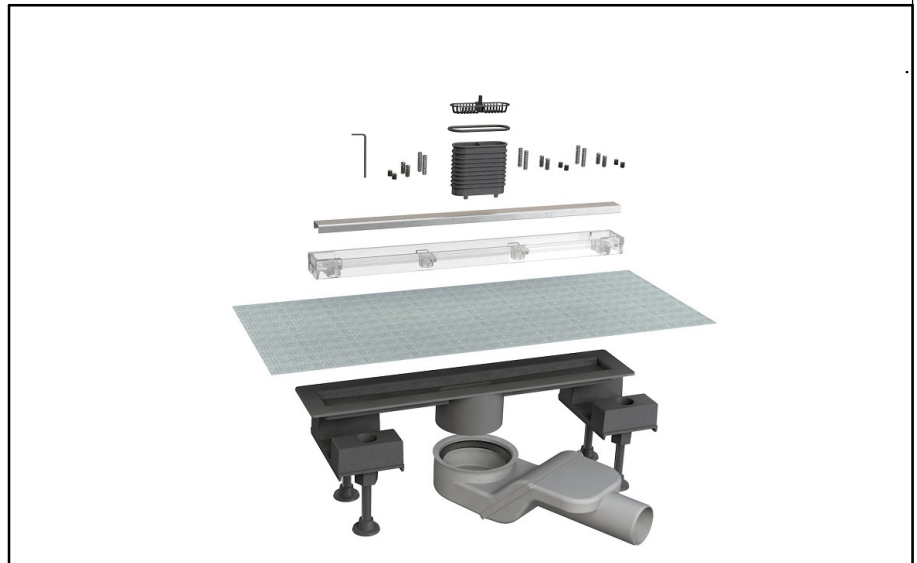

Logistic Info

Pcs per Carton:

Qty per Pallet:

Unit weight: 1,50400

Flow rate Lt/m.:

ORIGINE: MADE IN ITALY

Cod.EAN13: 8030575054322

Tarif Code :73249000

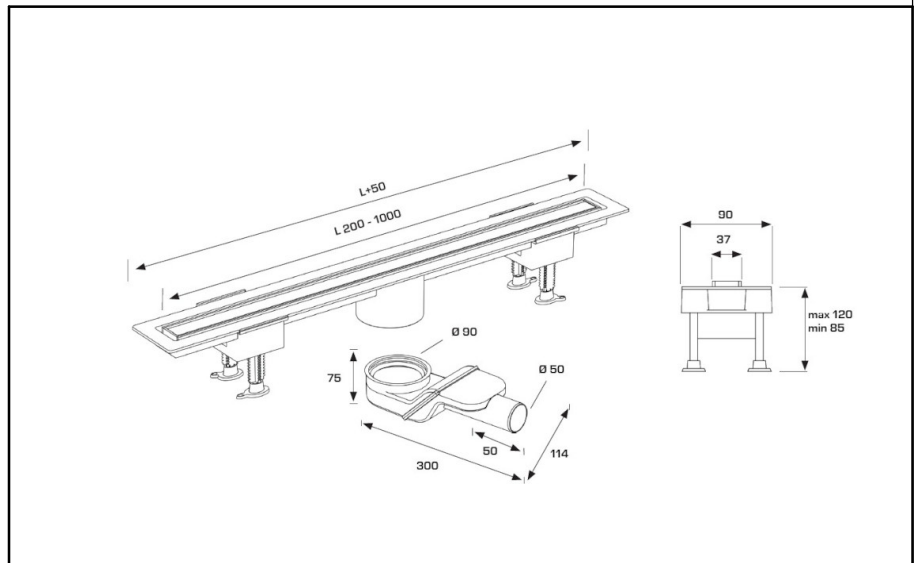

Tecnichal Details

Model: CANALISSIMA KIT - MIXAGE

Product: Channel drains with central outlet

Spec 1: "MIXAGE" adjustable tileable grid with PMMA frame and stainless steel AISI316 insert, waterproofing material and "SOGLIOLA" siphon

Spec 2: L 40 cm

Material 1: INOX

Material 2: ABS

Color 1: BRUSHED

Color 2: TRANSPARENT

Approvals