

ITEM

**6825HL30S**

**CANALISSIMA AL KIT ORIZ L30CM**

Product Type

Channel drains

Channel drains - kit

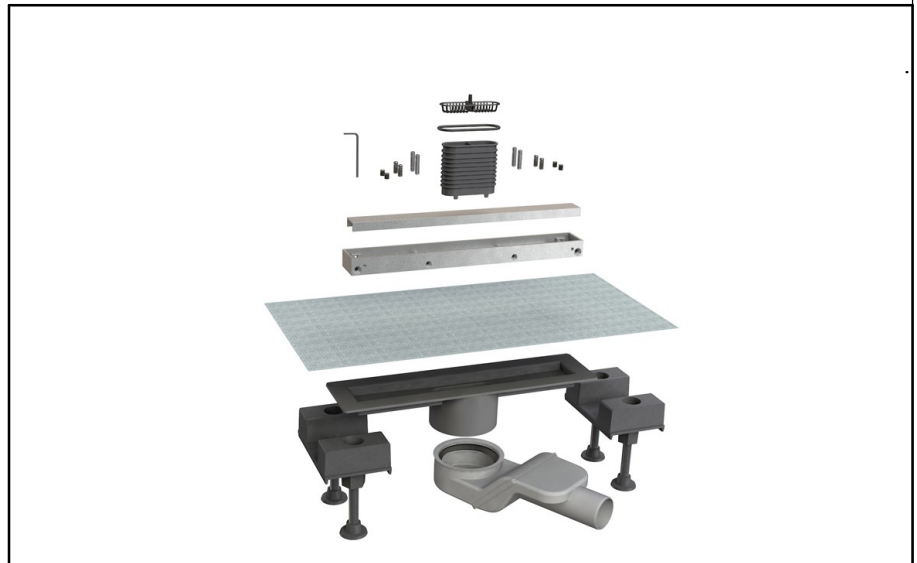

Logistic Info

**Pcs per Carton:**

**Qty per Pallet:**

**Unit weight: 1,37000**

**Flow rate Lt/m.:**

ORIGINE: MADE IN ITALY

Cod.EAN13: 8030575055596

Tarif Code :76169990

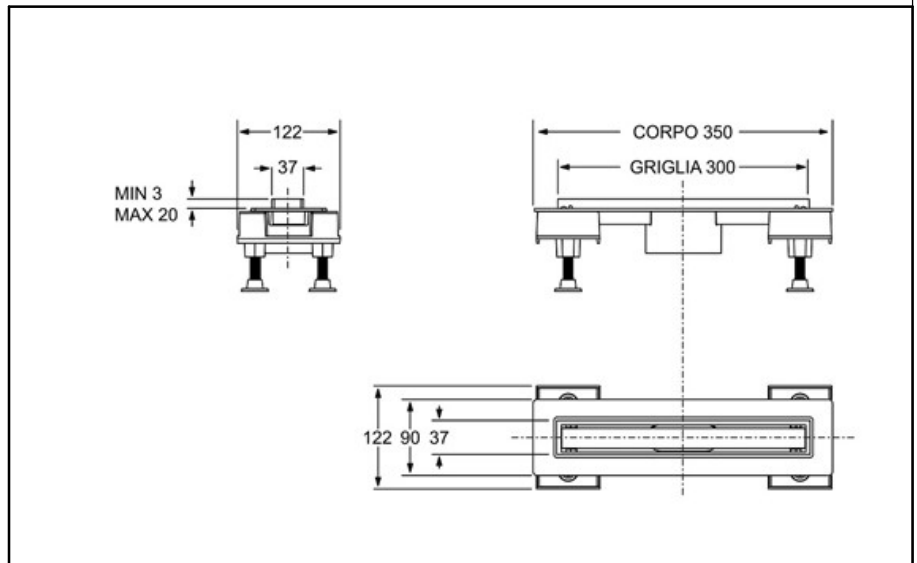

Tecnichal Details

**Model:** CANALISSIMA KIT - ALLUMINIO

**Product:** Channel drains with central outlet

**Spec 1:** "DOUBLE FACE" adjustable full aluminium tileable grid, waterproofing material and "SOGLIOLA" siphon

**Spec 2:** L 30 cm

**Material 1:** ALUMINUM

**Material 2:** ABS

**Color 1:** BRUSHED

**Color 2:** BLACK

Approvals