

ITEM

6310IX50S9

MNDRN PAVIMENTO Ø50 IX 10X10

Product Type

Floor drains

Odour traps



Logistic Info

Pcs per Carton: 10
Qty per Pallet: 10
Unit weight: 0,72500
Flow rate Lt/m.:

ORIGINE: MADE IN ITALY
Cod.EAN13: 8030575061634
Tarif Code :39229000

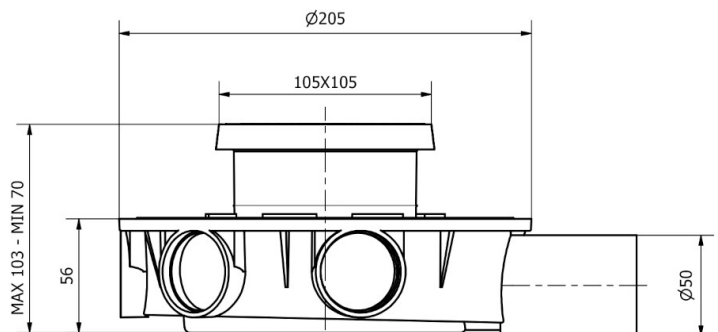

Tecnichal Details

Model: MIDI-DRAIN
Product: Drains with mechanical odour trap
Spec 1: Standard 10 x 10 cm flange, Mechanical odour trap in sylicone (NRV)
Spec 2: Outlet ø 50 mm, H 57 mm
Material 1: PP
Material 2: INOX
Color 1: BLACK
Color 2: METAL

Approvals