

ITEM

1720PP50S0

GALILEO 2 IN Ø40_OUT Ø50

Product Type

Traps and basket wastes for kitchen sinks

Kitchen sink space-saving traps



Logistic Info

Pcs per Carton: 10
Qty per Pallet:
Unit weight: 0,78800
Flow rate Lt/m.: 44,30

ORIGINE: MADE IN SERBIA

Cod.EAN13: 8030575061085

Tarif Code :39229000

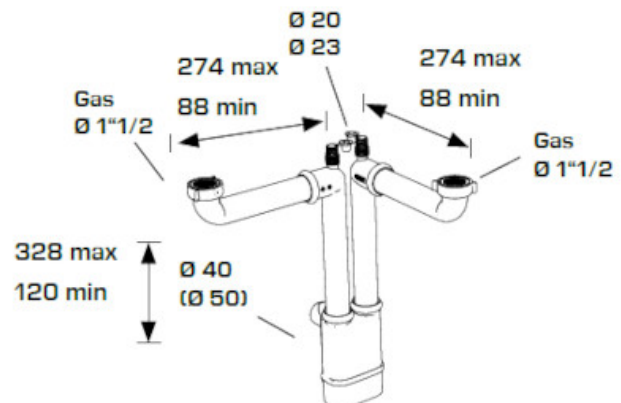

Tecnichal Details

Model: GALILEO

Product: Space saver traps for double waste kitchen sinks

Spec 1: With double connection for home appliances water discharge

Spec 2: 1"1/2 x Ø 50 mm

Material 1: PP

Material 2: Silicone

Color 1: WHITE

Color 2: GREEN

Approvals